

# ***JR3000 SERIES***

## ***Desktop Robot***

[ JR3200 / JR3300 / JR3400 / JR3500 / JR3600 ]



# Broaden your manufacturing potential with our

The JR3000 Series is a multifunctional robot designed with both cell production sites and automated inline installation in mind. With a rich catalog of functions including Fieldbus compatibility, a built-in LAN port as standard equipment, software that makes camera installation easy and the ability to control up to two external motors, the JR3000 is ready to fill many different manufacturing roles.

## Increased Structural Rigidity

We've made the robot even more rigid, which in turn makes it faster (maximum speed up to 900mm/s), more accurate, and able to operate non-stop for extended periods. We've stabilized the tracking function at high speeds. When a camera is attached to the Z-mechanism, the oscillation when the robot comes to a stop is greatly reduced, thereby cutting the wait time by approximately 50% (compared to previous Janome models).

## Hidden Robot Cable

New for desktop robots, the Z-axis cable is built into the Y-axis housing; a compact design ideal for workspaces with height limitations.

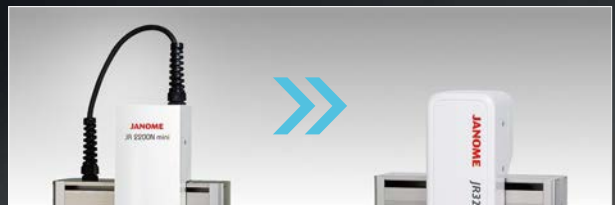

## Fieldbus Compatibility, Ethernet (LAN) Included as Standard Equipment

Choose from among 6 module types, including "CC-Link", "DeviceNet" or "PROFIBUS". A LAN port is included as standard equipment, so you can control several robots from one PC!



## USB Camera Teaching

Connect a store-bought USB camera\* and you can refer to enlarged camera images when teaching.

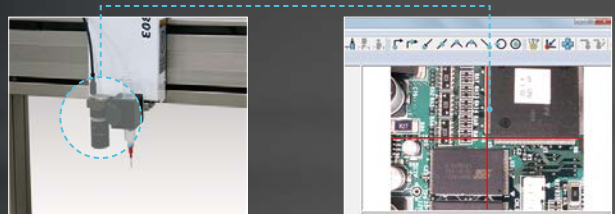

\* For information about compatible USB cameras, please contact us.

## Control up to 4 Axes and 2 External Motors

Program up to 2 pulse string input type devices, such as a stepping motor or pulse motor, the same as handling the robot axes from the teaching pendant. Set up a turntable to change the workpiece direction; install a conveyor and control it from the robot; the choice is yours.

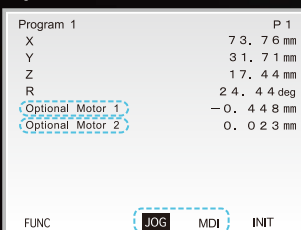

Make settings in either JOG or MDI Modes.



## Multilingual Display

We've equipped the teaching pendant with 11 different display languages so that operators from as many different countries as possible can easily program and operate the robot.

### Display Language Examples

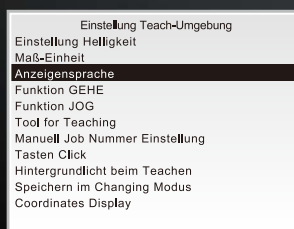

German

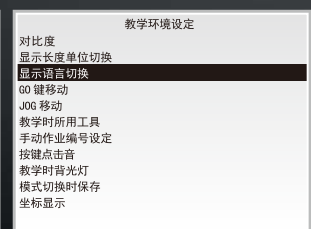

Chinese

# flagship desktop robot.

## Wide Variety of Model Variations

How to Read the Model Number

JR3	20	3	E	-	A	C
JR3000 Series	X, Y Axes Stroke	No. of Axes	Encoder		Operation Panel Specifications	Power Supply Specifications
	20 : 200×200mm 30 : 300×320mm 40 : 400×400mm 50 : 510×510mm 60 : 510×620mm	2 3 4	E:Included N:Not Included		A:Installed Switch Specifications B:Switchbox C:Basic Switchbox	C:100-120V/200-240V~ 50/60Hz (No Outlet) 200-240V~ 50/60Hz (200V Outlet) (mainly EU, Korea) J: 100-120V 50/60Hz (mainly Japan)

An encoder-equipped version which detects motor "step-outs"; a twin column type for the JR3400, useful for jobs that place a great load on the Z-axis; an elevated type with an extended Y-axis column for handling tall workpieces; we offer several optional variations to meet customer requirements. Also, CE compliant types are available for all models.

### Available Options at Time of Order

- Fieldbus Add-on (choose CC-Link, DeviceNet, PROFIBUS, CANopen, PROFINET or EtherNet/IP)
- I/O-MT Add-on (for up to 2 external motors)
- 3400 Series Double Column Type
- Elevated Column Type (open height)
- Optional Switch (Purging Switch Function for Dispensing Specs.)
- I/O-1 Add-on (8 Inputs/8 Outputs)
- Internal I/O Power Supply Add-on (DC24V Rating 2.1A)
- I/O-S Add-on (for Interlock connector)
- COM2, COM3 Add-on (for external devices)
- Ejector (air suction for screw tightening)

## Part Names and Explanations

JR3200 Reference Diagram

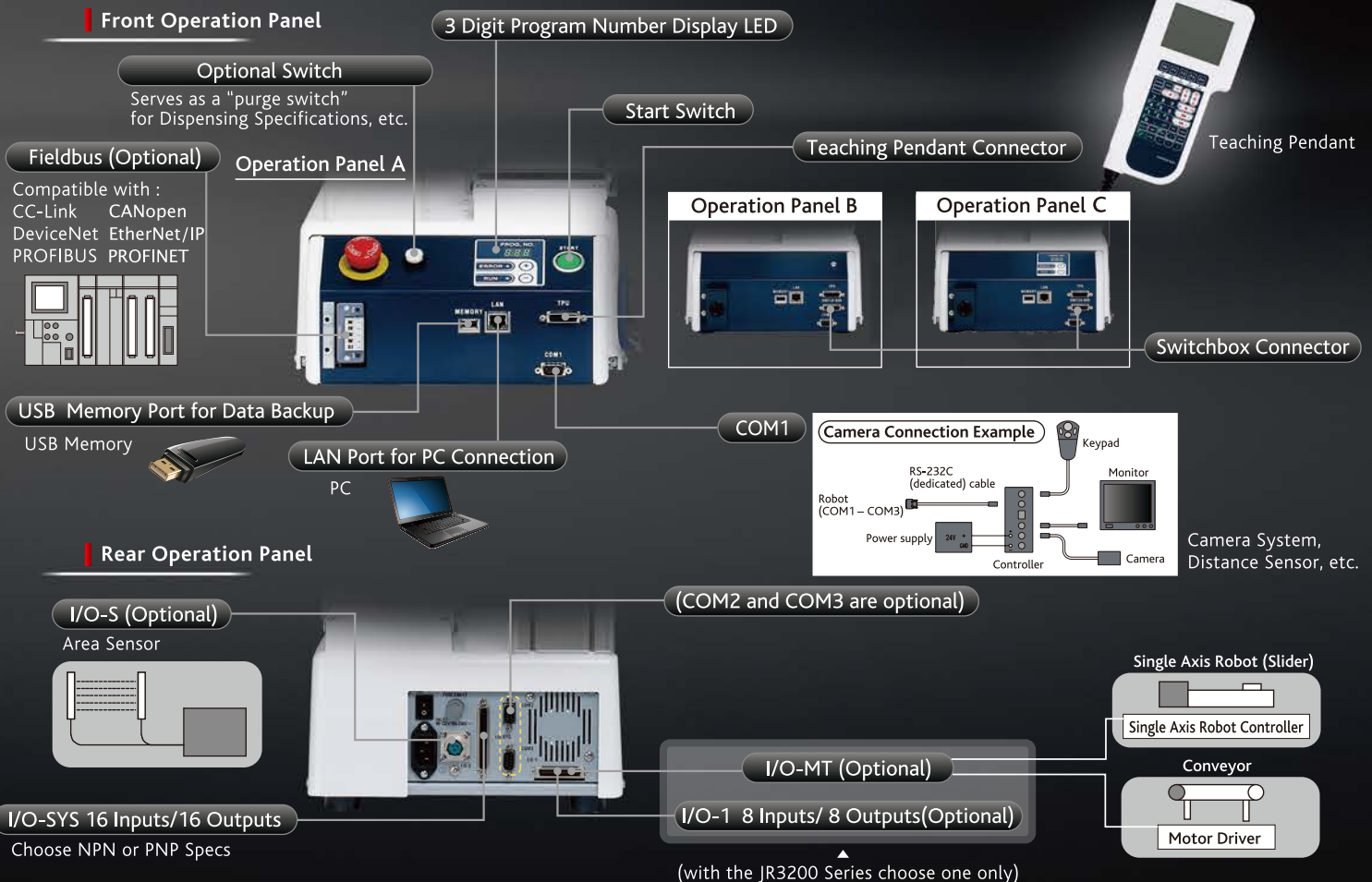



# Software

## System software for everyone, from first-time users to veteran operators.

The JR3000 features specialized software for each application that even a new programmer can use. Take advantage of a variety of proven command strings for easy robot teaching.

### CCD Camera Adjustment with Counter

Acquire up to 3,000 adjustment values when making camera position adjustments for the robot. After taking a series of camera shots, the robot can perform jobs while making a series of adjustments thereby shortening the cycle time.

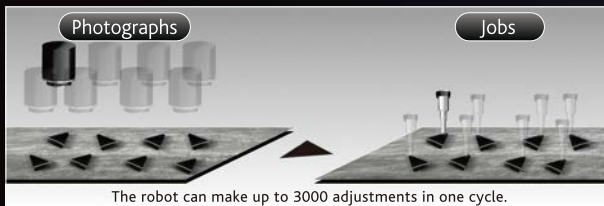

### Automatic Calibration

Camera calibrates automatically when a new camera system is added.

### Error History

The time and date an error occurs is now displayed. Knowing when an error occurs is helpful for cause determination and analysis.

Error History			2/2
15/ 7	2014	11:35:32	Error No.082
15/ 7	2014	12:20:45	Error No.007
15/ 7	2014	08:14:20	Error No.103

Error Description		Error No.007
15/ 7	2014 12:20:45	Error No.007
Error No.007 Position is out of range		

### Simple PLC Function

A simple PLC which operates independently from the robot's functions is already built-in, so you do not need to purchase a separate PLC to handle simple interfacing with external devices.

```

PLC 1 1/3
001 Id #genIn3
002 and #genIn5
003 out #genOut1
004 mps
005 Id #mv(1)
006 or #mv(2)
007 and #genIn2
008 out #genOut2
009 out #mv(3)
010 mrd
011 and #mv(3)
012 set #genOut3
    
```

### Common Settings for All Programs

You can make common settings for items which often use the same settings in multiple programs, such as "tool settings", etc. This is useful for shortening teaching time and revising parameters.

### Customizing Function

Register command strings that you often use and then when you need to teach a program it's easy! You can even create your own software.

## PC Software "JR C-Points II" (Optional)

"JR C-Points II" is application software which allows you to create, edit and save teaching and customizing data all on your PC. Convert teaching data created for the JR2000N Series on JR C-Points software for use with the JR3000.

### USB Camera Teaching

Connect a store-bought USB camera\* and you can refer to enlarged camera images when teaching.

**Programming Area**  
Displays point-based programming data. Pick the item you want and edit it directly.

**Camera Imaging Area**  
Use enlarged images to specify precise positions. Click on the display and the robot centers itself over that position! (3 Axes models only)

**Basic Operations Area**  
Program just by choosing the icons you want!

**Robot Operations Area**  
Make JOG movements while watching the camera image.

\* For information about compatible USB cameras, please contact us.

### Point Graphic Editing Function Screen

Create path data based upon DXF, Gerber or .JPEG background image data. Check and edit teaching data program paths. Optimize your programming potential by using several different functions to create even better teaching data.

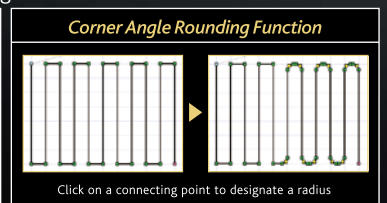
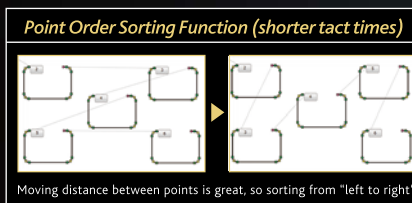
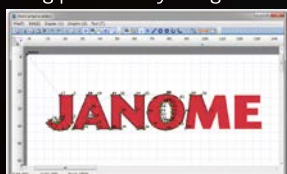
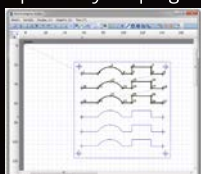

## Application Examples

The JR3000 is a versatile robot usable for a variety of manufacturing processes, including dispensing, screw-tightening, soldering, PC board depaneling, pick-and-place, testing and more. Use the I/O-MT function to control up to 2 external motors and/or a camera system to take advantage of the position correction function and further broaden the robot's usefulness. Here are some examples of applications where the JR3000 can work for you.

### Dispensing Robot

#### Easy

Using our dedicated dispensing application software, all you need to do is select the positions where you want the needle tip to go and dispense.

#### Convenient

The JR3000 is the ideal dispensing robot, fully equipped with helpful functions such as a fill-in dispensing function and a fragment prevention function as well as needle adjustment functions for 3 and 4 Axes types. Add an optional "Purging Switch", which runs the dispenser for as long as you press it.



Fill-in Dispensing Function

#### 4 Axes Needle Adjuster Function

We offer devices to adjust the needle tip position for both 3 and 4 Axes types (for Dispensing Specifications).

### Screw-tightening Robot

#### Easy

Using our dedicated screw tightening application software, after setting screw tightening conditions such as screw length, pitch and the number of driver rotations all you need to do to teach the robot is set the tightening positions.

#### Convenient

In addition to full tightening, the robot can also tighten loosely and loosen screws. Includes functions to detect screw stop and screw float errors. Other convenient functions include a program suspension function when the screw feeder becomes empty. (The screwdriver must also be adapted when loosening screws.)

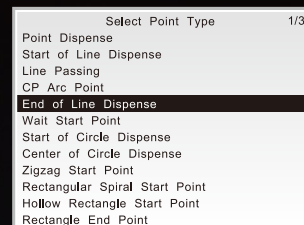

Dispensing Software Point Type Selection Screen



4 Axes Needle Adjuster

Screw Tightening Condition 1	
Type	Full Tightening(With Pickup)
Thread Pitch	0.25mm
Rotate Speed	6.50rpm
Screw Length	8mm
Check Precision	Normal
Float Amount	0.5mm
Time after tighten	0.2sec
Draw Amount	0mm
Screw Amount	0mm
Feeder	
Stop After Feeding	NO
Error Retry	YES

Screw-tightening Conditions Screen



Tightens screws as small as M1.0.

## Sample Uses for the I/O-MT

#### 4 Axes Dispensing Robot Used as a 6 Axis Unit

Axes are added to allow for changes to the dispenser syringe and workpiece angles. Here the robot dispenses along the edge of a hole cut through a tube-shaped piece.

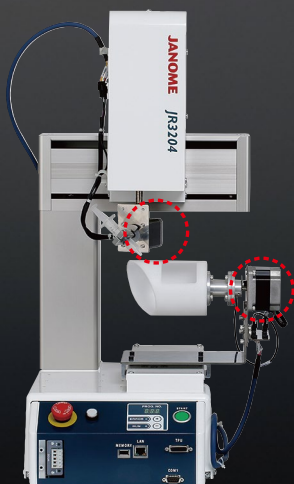

#### Dispensing on a Turntable

A 4 axes dispensing robot dispenses on multiple workpieces set on a rotating turntable.

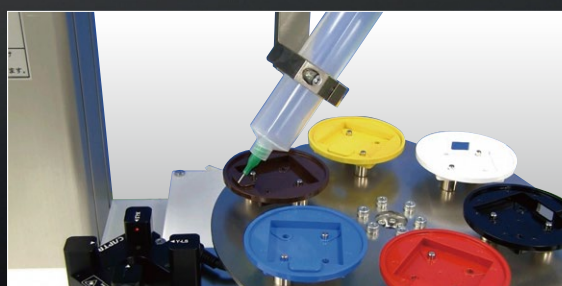

# External Dimensions

## JR3200

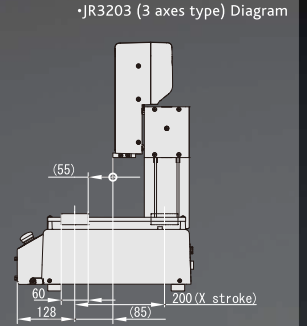
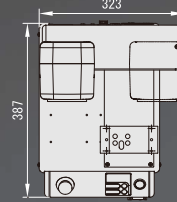
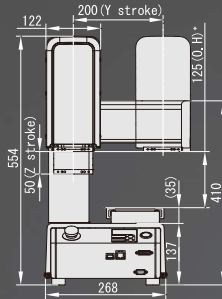

\*The standard open height for the JR3204 (4 axes type) is 205mm

## JR3300

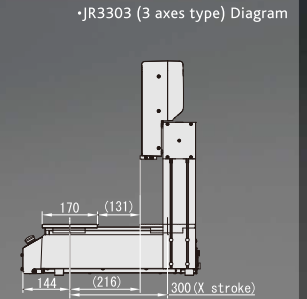
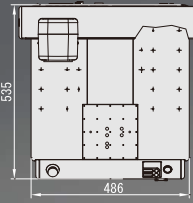
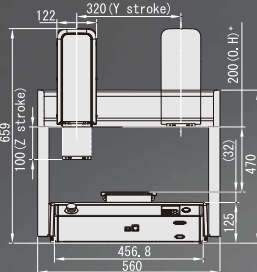

\*The standard open height for the JR3304 (4 axes type) is 350mm

## JR3400

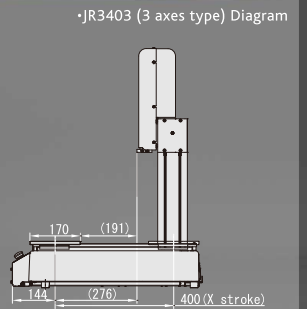
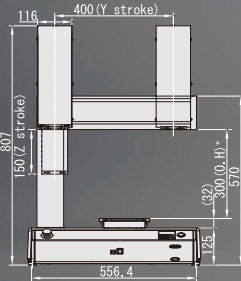

\*The standard open height for the JR3404 (4 axes type) is 350mm

## JR3500

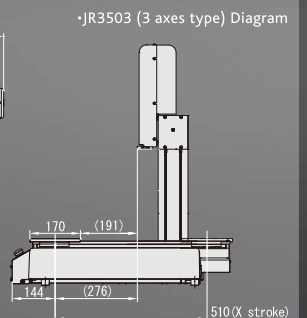
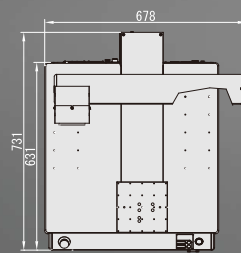
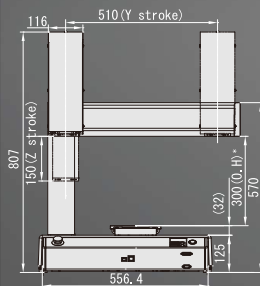

\*The standard open height for the JR3504 (4 axes type) is 350mm

## JR3600

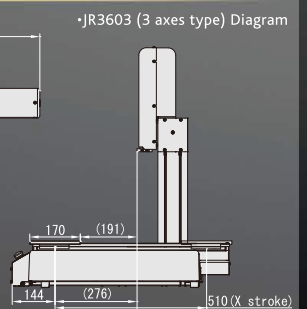
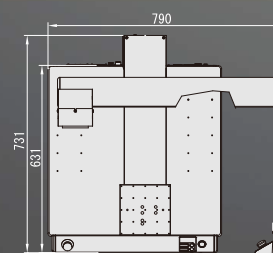
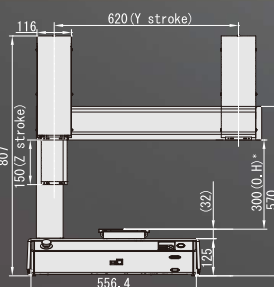

\*The standard open height for the JR3604 (4 axes type) is 350mm



# Main Specifications

## 3 Axes Specifications

Item		Model*1	3 Axes (Synchronous Control)				
			JR3203	JR3303	JR3403	JR3503	JR3603
Operating Range	X & Y Axes		200×200mm	300×320mm	400×400mm	510×510mm	510×620mm
	Z Axis		50mm	100mm	150mm	150mm	150mm
Maximum Portable Load	X Axis (Workpiece)		7kg	15kg	15kg	15kg	15kg
	Y Axis (Tool)		3.5kg	7kg	7kg	7kg	7kg
Maximum Speed (PTP Drive)*2 [ ]=Settable Speed Range	X & Y Axes		700mm/sec [7~700mm/sec]	900mm/sec [9~900mm/sec]	900mm/sec [9~900mm/sec]	900mm/sec [9~900mm/sec]	900mm/sec [9~900mm/sec]
	Z Axis		250mm/sec [2.5~250mm/sec]	400mm/sec [4~400mm/sec]	400mm/sec [4~400mm/sec]	400mm/sec [4~400mm/sec]	400mm/sec [4~400mm/sec]
Maximum Speed (CP Drive)*2 [ ]=Settable Speed Range	X, Y, Z Combined		600mm/sec [0.1~600mm/sec]	850mm/sec [0.1~850mm/sec]	850mm/sec [0.1~850mm/sec]	850mm/sec [0.1~850mm/sec]	850mm/sec [0.1~850mm/sec]
Repeatability*3	X & Y Axes		±0.006mm	±0.007mm	±0.007mm	±0.008mm	X:±0.008mm Y:±0.01mm
	Z Axis		±0.006mm	±0.007mm	±0.007mm	±0.008mm	±0.008mm
External Dimensions W×D×H (Excluding Protrusions) [ ]=Double Column Type			323×387×554mm	560×535×659mm	584×631×807mm [615×631×807mm]	678×731×807mm	790×731×807mm
Robot Weight [ ]=Double Column Type			20kg	35kg	42kg [45kg]	44kg	45kg

## 4 Axes Specifications

Item		Model*1	4 Axes (Synchronous Control)				
			JR3204	JR3304	JR3404	JR3504	JR3604
Operating Range	X & Y Axes		200×200mm	300×320mm	400×400mm	510×510mm	510×620mm
	Z Axis		50mm	100mm	150mm	150mm	150mm
	R Axis		±360°	±360°	±360°	±360°	±360°
Maximum Portable Load	X Axis (Workpiece)		7kg	15kg	15kg	15kg	15kg
	Y Axis (Tool)		3.5kg	7kg	7kg	7kg	7kg
Maximum Speed (PTP Drive)*2 [ ]=Settable Speed Range	X & Y Axes		700mm/sec [7~700mm/sec]	900mm/sec [9~900mm/sec]	900mm/sec [9~900mm/sec]	900mm/sec [9~900mm/sec]	900mm/sec [9~900mm/sec]
	Z Axis		250mm/sec [2.5~250mm/sec]	400mm/sec [4~400mm/sec]	400mm/sec [4~400mm/sec]	400mm/sec [4~400mm/sec]	400mm/sec [4~400mm/sec]
	R Axis		600°/sec [6~600°/sec]	900°/sec [9~900°/sec]	900°/sec [9~900°/sec]	900°/sec [9~900°/sec]	900°/sec [9~900°/sec]
Maximum Speed (CP Drive)*2 [ ]=Settable Speed Range	X, Y, Z Combined		600mm/sec [0.1~600mm/sec]	850mm/sec [0.1~850mm/sec]	850mm/sec [0.1~850mm/sec]	850mm/sec [0.1~850mm/sec]	850mm/sec [0.1~850mm/sec]
R Axis Acceptable Moment of Inertia			65kg·cm <sup>2</sup>	90kg·cm <sup>2</sup>	90kg·cm <sup>2</sup>	90kg·cm <sup>2</sup>	90kg·cm <sup>2</sup>
Repeatability*3	X & Y Axes		±0.01mm	±0.01mm	±0.01mm	±0.01mm	±0.01mm
	Z Axis		±0.01mm	±0.01mm	±0.01mm	±0.01mm	±0.01mm
	R Axis		±0.008°	±0.008°	±0.008°	±0.008°	±0.008°
External Dimensions W×D×H (Excluding Protrusions) [ ]=Double Column Type			323×387×676mm	560×535×844mm	584×631×894mm [615×631×894mm]	678×731×894mm	790×731×894mm
Robot Weight [ ]=Double Column Type			22kg	38kg	46kg [49kg]	47kg	48kg

### <Notes>

\*1 Z Axes Specifications also available. Please contact us.

\*2 Maximum speed can vary depending upon conditions. The robot cannot reach maximum speed when bearing the maximum portable load.

\*3 Repeatability was measured at a constant temperature and does not represent a guarantee of absolute precision.

## JR3000 Series Common Specifications

Item	Specification Content	
Drive Method	5 Phase Pulse Motor (optional encoder attachment)	
Control Method	PTP(Point to Point) Control, CP(Continuous Path) Control	
Interpolation	3-dimensional linear and arc interpolation	
Teaching Method	Remote Teaching (JOG) / Manual Data Input (MDI)	
Teaching System	Simple and versatile teaching using our original software •Easy: Point-based teaching (position and type) for all axis movement; direct movement by setting point strings. Dedicated point types for each application makes teaching specialized movements simple. •Versatile: Control tools and make workpiece operation settings by setting point jobs and various parameters.	
Teaching Pattern	•Direct teaching using the optional teaching pendant •Offline teaching from a PC using our optional PC software "JR C-Points II". Compatible with CAD graphics (DXF, Gerber, JPEG)	
Screen Display Options	Measurement Unit mm, inch	
	Languages Japanese, English, French, Spanish, Italian, German, Korean, Simplified Chinese, Traditional Chinese, Czech, Vietnamese	
Program Capacity	999 Programs	
Database Capacity*1	Up to 32,000 points	
Simple PLC Functions	Up to 100 programs, with up to 1,000 steps/program	
External Input/Output	I/O-SYS	16 Inputs/ 16 Outputs
	I/O-1*2	8 Inputs/ 8 Outputs (including 4 relay outputs) (Optional)
	I/O-MT*2	Controls up to 2 external motors (Optional)
	I/O-S	Interlock connector for an area sensor, etc. (Optional)
	Fieldbus	CC-Link/ DeviceNet/ PROFIBUS/ PROFINET/ CANopen/ EtherNet/IP (Optional)
	COM1	RS232C (for external devices, COM commands)
	COM2・COM3	RS232C (for external devices) (Optional)
	MEMORY USB memory connector (save and readout teaching and customizing data, back up system software)	
	LAN*3 Ethernet connector for PC (connect to JR C-Points II PC software, operate the robot using control commands)	
Power Source	AC100~120V / AC200~240V (single phase)	
Power Consumption	200W	
Operating Environment	Temperature	0~40°C
	Relative Humidity	20~90% (non condensing)
	Elevation	up to 1,000m

### <Notes>

\*1 Point data memory capacity reduces as additional function data settings/point job data/sequencer data are added, due to the shared data storage area.

\*2 For the JR3200 series, choose only one optional add-on: I/O-1 or I/O-MT.

\*3 Ethernet connection is 10BASE-T/100BASE-TX.

### <Standard Accessories>

- Operation Manual (CD-ROM)
- Power Cord
- Switchbox (included as standard equipment for robots with B type specification operation panels)
- Basic Switchbox (included as standard equipment for robots with C type specification operation panels)

### <Options>

- Teaching Pendant (Standard/with Emergency Stop Switch/with Emergency Stop Switch+Enable Switch)
- PC Software JR C-Points II (Windows®7/Windows®8.1/Windows®10 compatible) Switch among Japanese, English, German and Simplified Chinese display screens.
- Internal I/O Power Supply (DC24V Rating 2.1A for I/O-SYS and I/O-1)
- Optional Switch (Option with A Type Operation panel specs.)
- Needle Adjuster
- I/O-SYS Connector
- I/O-SYS Cable (2m/3m/5m)
- I/O-1 Connector
- I/O-1 Cable (2m)
- I/O-MT Connector
- I/O-MT Cable (0.5m/1m/3m/5m)
- I/O-S Connector

## Switchbox

	Standard Type	With Mode Changing Switch (optional)	With Optional Switch (optional)	With Mode Changing Switch + Optional Switch (optional)
Switchbox (Operation Panel B Type)				
Basic Switchbox (Operation Panel C Type)				

\*Add up to 2 optional switches.

- Before using your robot, read the operation manual and be sure to use the robot correctly.
- Specifications may change without notice to improve product quality.
- If you have any questions, please contact us at the telephone number listed below, or visit our website.

C24-00(06.1)EN 2017.09-000

## Janome Sewing Machine Co., Ltd. Industrial Equipment Sales Division

1463 Hazama-machi, Hachioji-shi, Tokyo 193-0941  
 Tel: +81-42-661-6301 FAX: +81-42-661-6302  
 E-mail : j-industry@gm.janome.co.jp  
 URL: <http://www.janome.co.jp/industrial.html>

Distributor